



CLASSIC II™

Portable Braking System

Inventor and Leader in Portable Technology!



INSTRUCTIONS

NEED HELP? CALL - 1-800-470-2287

(MONDAY - FRIDAY 8AM - 5PM CST)

WARNING

Read all instructions before installing or operating the Classic II™.

Failure to understand how to install or operate Classic II™ could result in property damage, personal injury or death.

INSIDE THE BOX

PRIOR TO THE SET-UP OF BRAKEBUDDY® CLASSIC II™, REMOVE ALL CONTENTS FROM THE SHIPPING PACKAGE.

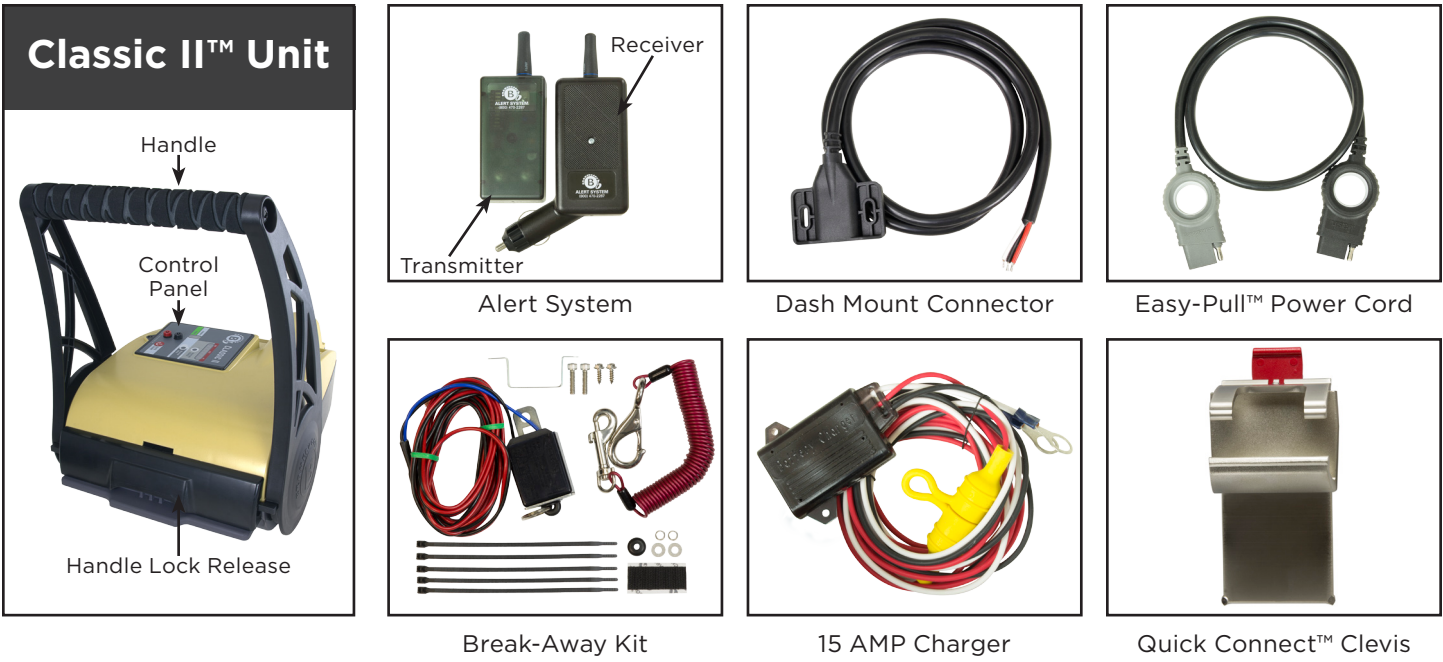

NOTE: If there is ANY shipping damage, immediately call BrakeBuddy® Technical Service at 800-470-2287

BRAKEBUDDY® UNDER TOWED VEHICLE HOOD WIRING

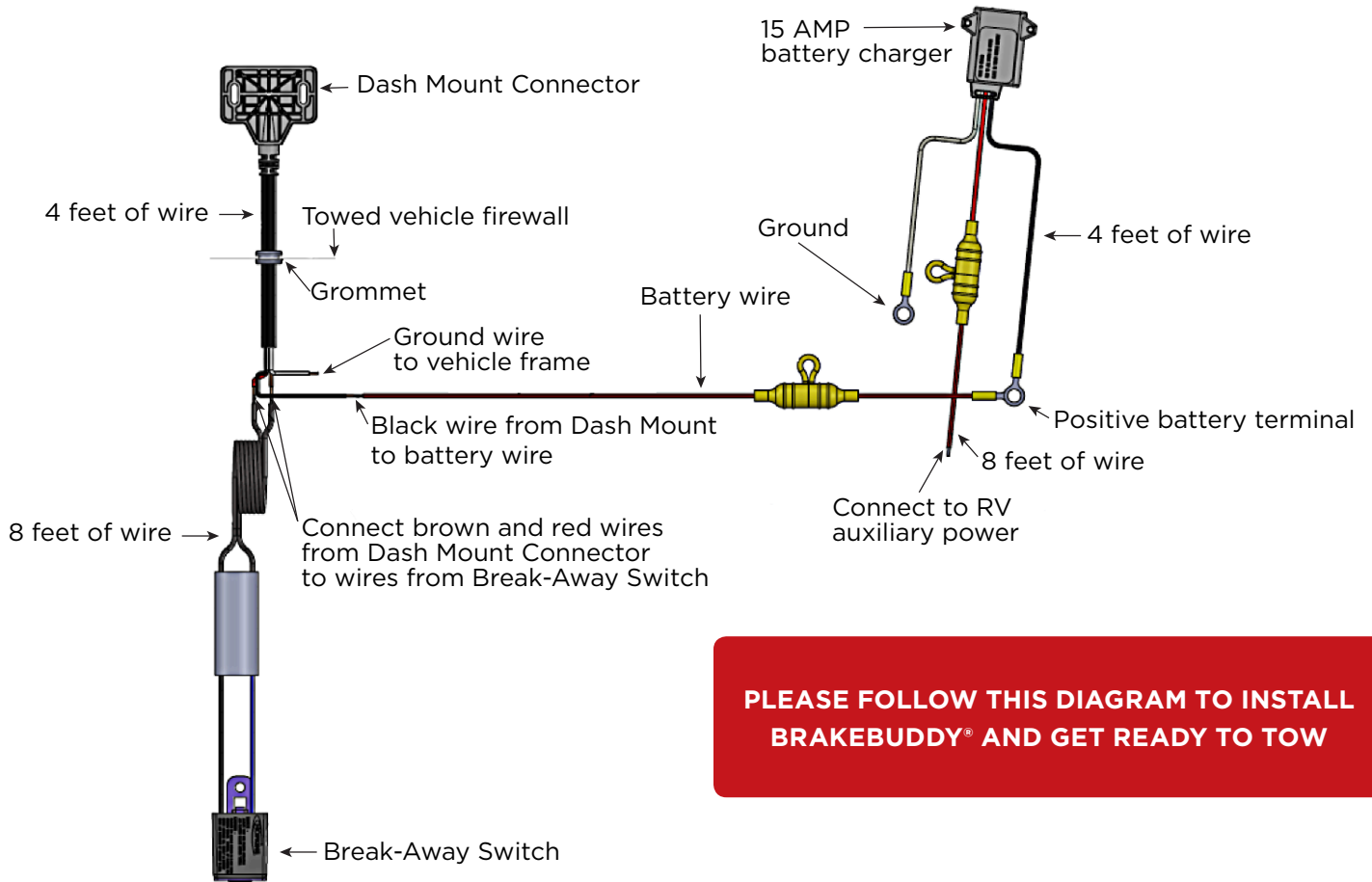

PLEASE FOLLOW THIS DIAGRAM TO INSTALL BRAKEBUDDY® AND GET READY TO TOW

INSTALL DASH MOUNT CONNECTOR

1. Look under dash in towed vehicle driver side for grommets or holes to come through the firewall.

NOTE: Please do not drill before making sure there is nothing behind the firewall that may cause damage to your vehicle.

2. Drill a hole wide enough to route the wiring from the Dash Mount Connector through the firewall to the battery.
3. Select mounting location for Dash Mount Connector and route wire from inside of vehicle through firewall into the engine compartment. Use provided grommet to protect wire.
4. Use 2 ¼" screws, 2 washers and 2 nuts to secure Dash Mount Connector to vehicle dash.

BREAK-AWAY INSTALLATION

THE BREAK-AWAY IS AN IMPORTANT PART OF THE BRAKEBUDDY® SYSTEM AND IS REQUIRED BY LAW IN MOST STATES. DO NOT OPERATE YOUR BRAKEBUDDY® WITHOUT A PROPERLY FUNCTIONING BREAK-AWAY.

INSTALLING JUNCTION BOX

1. Find a convenient, sturdy place on the front of your towed vehicle to mount the junction box **(B)**. This should be installed on the driver's side of the vehicle if possible.
2. Clean the mounting surface and attach the Velcro patch **(A)** (Fig. 1)
3. Attach the junction box **(B)** to the velcro patch **(A)** so the pin with the ring faces forward and the wiring harness feeds back into the engine compartment.
4. Place the mounting bracket **(C)** over the junction box **(B)** and mark the hole locations to be drilled and tapped.
5. Remove bracket **(C)** and junction box **(B)**. Drill marked holes with a 1/8" metal drill bit.

NOTE: For thin sheet metal or plastic, it may be necessary to reinforce the plastic or thin metal to ensure bracket will not separate from the vehicle when the break-away pin is pulled. If you are going to drill through thicker metal, use hex socket head capscrews **(D)**. You will need to drill a hole using a #25 drill bit and tap the hole using a 10-24 tap.

6. Replace the junction box **(B)** and attach the bracket **(C)** using hex socket head capscrews **(D)** or sheet metal screws **(E)** provided (Fig. 2).

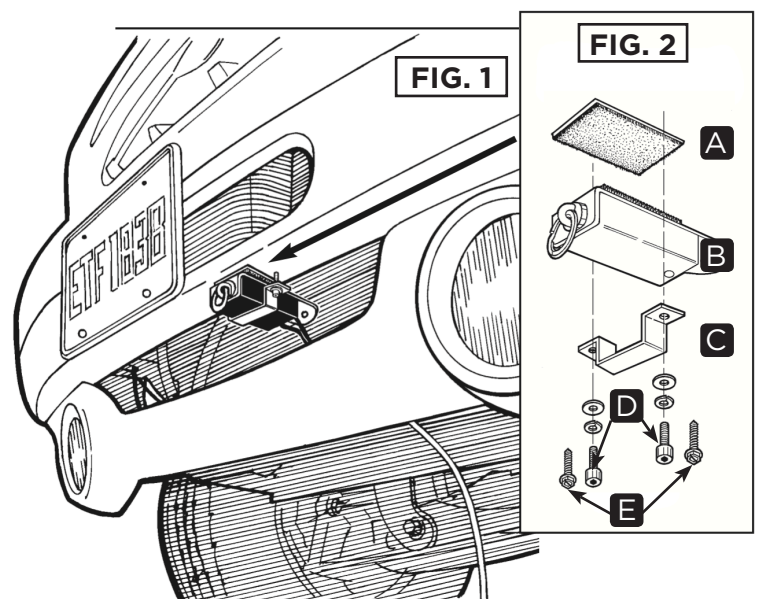

USING THE BREAK-AWAY SYSTEM

After attaching your towed vehicle to your coach and all hook-ups are complete, you will need to attach the break-away cable from the junction box to the motorhome. **DO NOT ATTACH OR WRAP THE CABLE AROUND THE TOW BAR, HITCH OR BUMPER.**

1. Attach the small clip on the cable to the loop on the pull pin of the junction box, and then attach the large clip to the motorhome. The coiled break-away cable fits all applications and needs no adjustment.
2. Install the BrakeBuddy® in your towed vehicle
3. Before the start of every trip, pull the break-away pin to test that the break-away system activates the BrakeBuddy®.
4. When the use of the towed vehicle is needed, simply unhook the small clip from the loop on the pull pin of the junction box. Unplug the power cord from the BrakeBuddy® and the Dash Mount Connector. Store power cord with BrakeBuddy®.

SET UP

1. Lift lever on back of unit to pull handle up into ready position.
2. Insert the "Grey" end of the power cord into front of unit.
3. Attach the lock nut and clevis assembly to the arm extension.
4. Place BrakeBuddy® in floor of drivers side towed vehicle.
5. Attach clevis to brake pedal.
6. Move BrakeBuddy® forward until the arm extension is fully retracted. Make sure the vehicle's brake pedal is not being pressed.
7. Adjust the drivers seat forward until it is less than a quarter inch away from the BrakeBuddy® handle. Again, make sure the vehicles brake pedal is not being pressed.
8. Plug in "Black" end of the power cord into Dash Mount Connector.
9. With vehicle's engine OFF, push the red Auto Start Button located on top of the BrakeBuddy®. The arm will automatically extend / cycle 5 times. This will remove any vacuum stored in the brake vacuum reservoir of the towed vehicle as well as diagnose any errors in the system startup.
10. Plug in Alert System: Transmitter goes in top of unit and Receiver goes in 12-Volt outlet of the motorhome.



1. Lever to raise handle

Ready position - this is how the unit should look prior to placing in floor of towed vehicle



2. Insert power cord

ALERT SYSTEM INSTALLATION

The Alert System is a wireless monitor that illuminates on your motorhome's dashboard when the BrakeBuddy is activated telling you that the BrakeBuddy is working properly. This system consists of two parts, the Transmitter and the Receiver.

The **Alert System Receiver** (Fig. 3 / **A**) plugs into a 12-volt outlet on the dash of the motorhome. When the BrakeBuddy® is activated in the towed vehicle, the Receiver will illuminate.

The receiver will continually flash red if the towed vehicle's battery drops below 10 volts. At this time you need to stop and restart your towed vehicle to recharge the battery. Remember, always relieve the brake vacuum after shutting the towed vehicle's engine off.

If the towed vehicle breaks away from the motorhome the receiver gives an audible signal and flashes red. The audible will sound until the break-away pin is reinserted.

The **Transmitter** (Fig. 4 / **B**) plugs into the top of the BrakeBuddy® and sends a signal to the Receiver when the BrakeBuddy® is activated. Plug the transmitter into the connections on the BrakeBuddy® (Fig. 4). The antenna should point toward the motorhome.

Test Procedure

Perform each time before use

Before you begin towing, a simple test should be performed to assure your Alert System is operating properly. Have someone push the Auto Start button on the BrakeBuddy®. The Receiver should illuminate upon activation. **Do not do this while the motorhome is moving!** The Alert Receiver will illuminate: (1) when the Auto Start button is pressed; (2) when the BrakeBuddy® activates as a result of forward inertia (i.e., the braking of the motorhome) ; or (3) if the Break-Away pin is pulled.

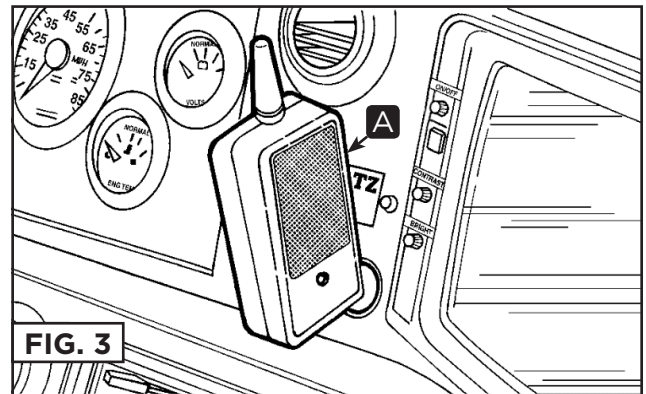

FIG. 3

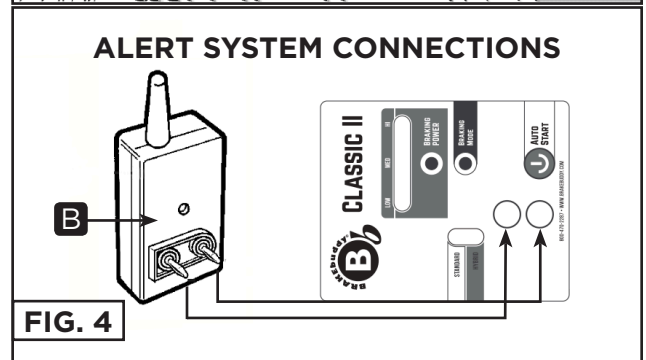

FIG. 4

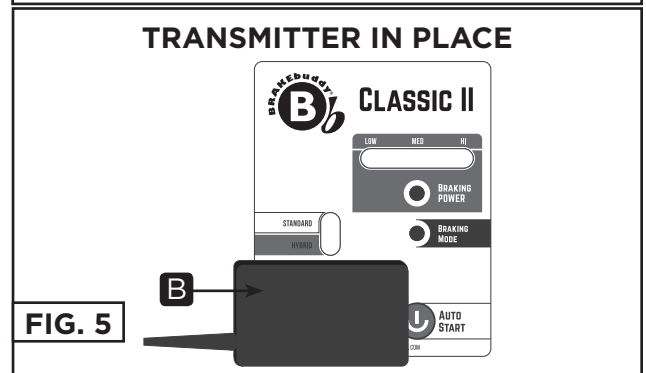
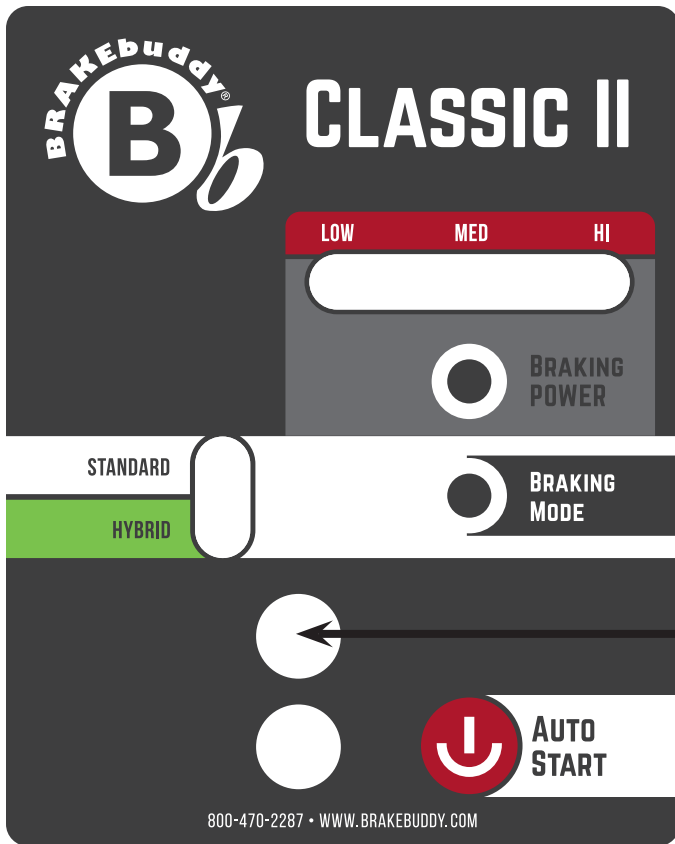

FIG. 5

NOTE: In the unlikely circumstance that the Receiver is plugged into a 12-volt outlet within 5 feet of the main unit, the Receiver will not confirm braking activity. The BrakeBuddy® Classic II™ will continue to operate the braking function, but the Receiver will not glow red to confirm braking.

NOTE: An optional transmitter extension cord is available if the signal is not reaching the receiver. Call BrakeBuddy® customer service, 1-800-470-2287



DIAGNOSTIC FEATURES

BRAKING POWER - Amount of force applied to your towed vehicles brake. Pressing this button will adjust power up from low to hi.

BRAKING MODE - Press button to be in correct mode for your towed vehicle

BLEED BRAKES - Depress Auto Start button

INSERT TRANSMITTER FOR ALERT
Transmitter antenna should face towards the RV (forward).

NOTE: Plugging in backwards could damage electronics

REMOVAL INSTRUCTIONS

1. To remove the BrakeBuddy® from your towed vehicle, unplug Easy-Pull™ Power Cord from unit and Dash Mount Connector
2. Adjust the seat back and remove the clevis
3. Disconnect (unclip) the break-away safety coil from the break-away junction box

Information to User:

NOTE: This equipment has been tested and found to comply with the limits for a Class B digital device, pursuant to part 15 of the FCC Rules. These limits are designed to provide reasonable protection against harmful interference in a residential installation. FCC Radiation Exposure Statement to comply with FCC RF exposure requirements in section 1.1307, a minimum separation distance of 1.40 cm (0.6 inches) is required between the antenna and all persons. This equipment generates, uses and can radiate radio frequency energy and, if not installed and used in accordance with the instructions, may cause harmful interference to radio communications. However, there is no guarantee that interference will not occur in a particular installation. If this equipment does cause harmful interference to radio or television reception, which can be determined by turning the equipment off and on, the user is encouraged to try to correct the interference by one or more of the following measures:

- Reorient or relocate the receiving antenna
- Increase the separation between the equipment and receiver
- Connect the equipment into an outlet on a circuit different from that to which the receiver is connected
- Consult the dealer or an experienced radio / TV technician for help

CAUTION: Changes or modifications not expressly approved by Hopkins Manufacturing Corporation could void the user's authority to operate the equipment.

LIMITED 5-YEAR WARRANTY

Hopkins Manufacturing Corporation thanks you for purchasing BrakeBuddy®. A 5-year limited warranty and a 30-day money back guarantee apply to your BrakeBuddy® and BrakeBuddy® accessories. Call BrakeBuddy® customer service at 1-800-470-2287. We wish you safe and happy travels.

WHAT IS COVERED AND FOR HOW LONG?

We are confident our product will perform well and therefore warrant to you, as the original retail purchaser, for a period of five years from the date of original purchase, that your new product will be free of mechanical and electrical defects in material and workmanship.

WHAT WILL BRAKEBUDDY® DO? HOW DO I GET SERVICE?

During the warranty period, we will repair or replace your new product (at our option) without cost to you, which will be your exclusive remedy under this warranty. **Please do not return this product to the place of purchase. Doing so may delay the processing of your claim and our repair of your product. Return your product postage prepaid, with proof of purchase and a short description of the problem.**

Call BrakeBuddy® Technical Service for return instructions 1-800-470-2287

WHAT IS NOT COVERED?

Our warranty for your product will not cover damage resulting from neglect or misuse of the product, use of improper voltage or current, use contrary to operating instructions, or disassembly, repair, or alteration by any person other than an authorized service station. Any implied warranty of merchantability or fitness for a particular purpose of your product is limited to the duration of this written warranty. We shall not be liable for any incidental or consequential damages for breach of any expressed or implied warranty on your product.

HOW YOUR STATE'S LAWS MAY APPLY:

Some states do not allow limitations on how long an implied warranty lasts or the exclusion or limitation of incidental or consequential damages, so the above limitation may not apply to you. This warranty gives you specific legal rights, and you may also have other rights, which vary from state to state.